

Dual Lumen Breathing Circuit

- A. Coaxial Bacterial/Viral Filter (B/V Filter)
- B. Coaxial Tubing
- C. Standard Filter Trap
- D. Handset
- E. Aerogen® Solo Nebulizer
- F. Two-step adapter (optional)
- G. Face Mask (optional)
- H. Trach Adapter (optional)
- I. Mouthpiece (optional)

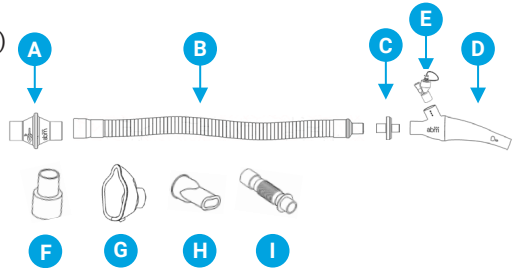

1. Attach the larger end of the coaxial tube (B) to the end of the coaxial B/V filter (A) that has the company logo as shown in [FIGURE 1](#).
2. Connect the end of the coaxial B/V filter (A) with the oxygen port to the patient port of the control unit, as shown in [FIGURE 2](#).
3. On the back of the control unit, locate the power switch (J) as shown in [FIGURE 3](#). Flip the power switch to the ON position.
4. Connect the smaller end of the coaxial tube (B) to the standard filter trap (C). Insert the handset (D) into the standard filter trap. Next, insert the Aerogen® Solo nebulizer (E) into the nebulizer port of the handset (D), as shown in [FIGURE 4](#). Finally attach the appropriate patient interface as shown below.

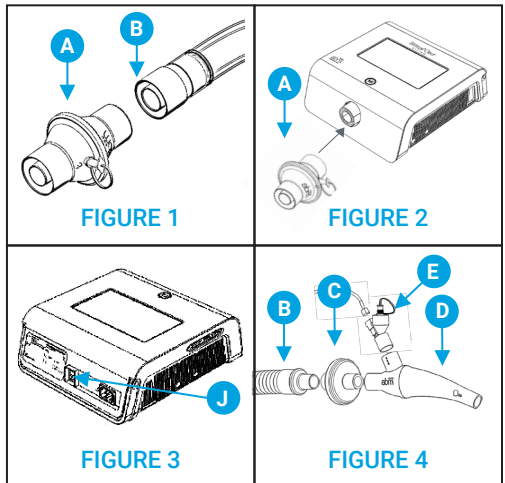

Patient Interface

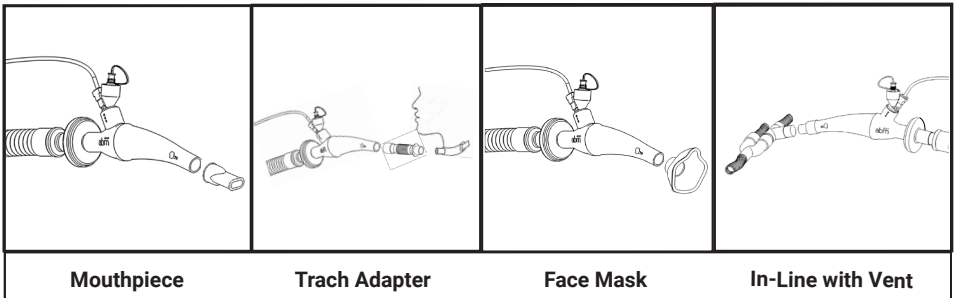

Mouthpiece

Trach Adapter

Face Mask

In-Line with Vent

Auto Therapy Mode



1. The system shows the last therapy used by default. If profiles are setup, you can select a profile from the dropdown list.
2. To start therapy, press the play/start icon on the bottom of the screen.

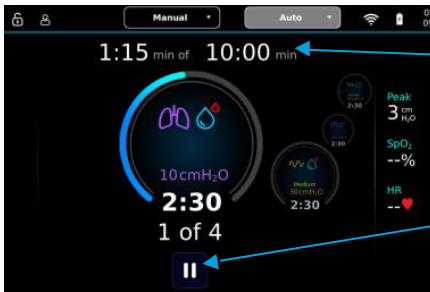

3. The current phase of therapy being delivered is shown in the center circle and the upcoming phases are the smaller circles to the right. The therapy timer is displayed above the therapy phase circles.
4. You can pause the therapy at any time by pressing the pause icon on the bottom of the screen.

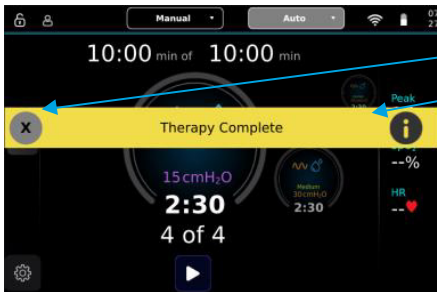

5. Once the therapy ends, a therapy complete ribbon will appear. You can select to view the therapy details by pressing the i icon or close the ribbon by pressing the x icon.

Manual Therapy Mode



1. The circles in the middle represent different therapy phases. The PEP and OSC therapies can be edited by pressing on their respective circles.
2. To start the therapy, press the start/play icon on the bottom of the screen to engage the blowers. **Note:** no therapy will be delivered until a therapy phase circle is selected.

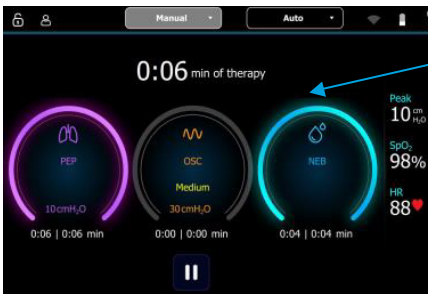

3. Tap the therapy phase you want to deliver, PEP and OSC can be delivered with or without NEB. Also, NEB can be delivered alone. A color will illuminate around a phase when it is being delivered.

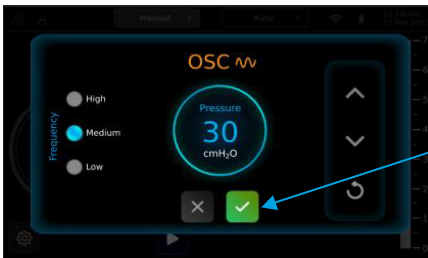

4. To edit the phase therapy settings while the therapy is being delivered, conduct a long press on the therapy phase circle to open the settings window. Adjustment to the therapy settings will occur real time. Press the green check mark to save the adjustments and return to the manual mode screen.

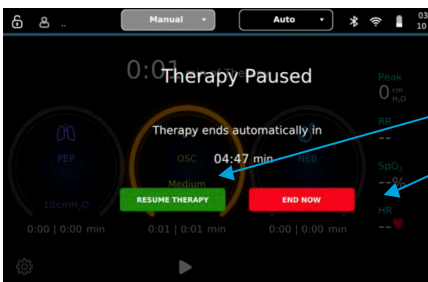

5. When the therapy is paused, it will remain paused for 5 minutes until it is automatically end. Otherwise, Resume Therapy or End Now by pressing on their respective buttons.

In-Line with a Ventilator



WARNING – BiWaze Clear should only be operated by trained personnel, and therapy on ventilated patients should exclusively be performed by healthcare professionals trained on how to operate the ventilator.

WARNING – Only use OSC therapy with or without NEB when BiWaze Clear is delivering therapy in-line with a ventilator. Do not use PEP or NEB only therapy in-line with a ventilator.

WARNING – Any ventilator adjustments for BiWaze Clear therapy must be performed by a trained healthcare professional in an acute care environment.

WARNING – Patients must be monitored for signs of respiratory distress during BiWaze Clear therapy in-line with a ventilator.

WARNING - Volume modes are not uniform across different ventilators and therefore not recommended to be used with BiWaze Clear. The delivered volumes may vary significantly due to leakage calculations and dynamic lung mechanics measurements to administer set volumes, which may vary widely among ventilators from different manufacturers.

WARNING - If the patient is showing signs of respiratory distress (wheezing, color change around the mouth, lips or fingernails, or drop in oxygen saturation level, etc) discontinue BiWaze Clear therapy immediately.

WARNING - Do not leave BiWaze Clear connected in-line after the BiWaze Clear therapy is complete. Leaving the system connected when BiWaze Clear therapy is not running could cause a loss in pressure in the ventilator circuit.

When delivering BiWaze Clear therapy in-line with a ventilator, it's recommended to use pressure control ventilation mode (PCV).

Also, it is recommended to use a spring-valve tee adapter in-line with the ventilator circuit proximal to the patient to minimize ventilation therapy interruption when connecting the BiWaze Clear Dual Lumen Breathing Circuit.

1. Select the therapy mode on BiWaze Clear from the top menu bar.

Note: It is recommended to use Manual Mode so the therapy doesn't stop automatically.

2. Ensure the prescribed therapy settings are displayed on BiWaze Clear.

Note: OSC pressure should match the Peak Inspiratory Pressure (PIP) setting on the ventilator.

3. Position the head of the patient's bed at 30 degree angle, if possible.

4. Start the therapy on BiWaze Clear prior to connecting Dual Lumen Breathing Circuit to the ventilator circuit.

5. Connect the Dual Lumen Breathing Circuit with a two-step adapter (A) to a spring-valve “tee” adapter (B) in the inspiratory limb of the ventilator circuit.

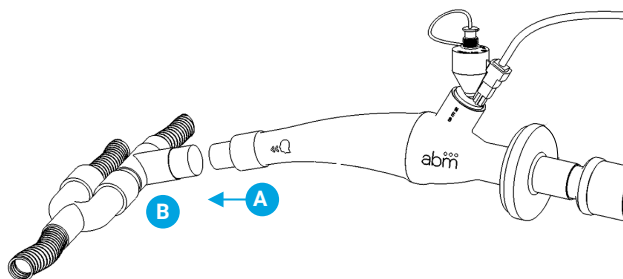

Note: You may see an increase in the pressure reading when BiWaze Clear is initially placed in-line. See the user manual for product performance and validation information with various ventilators.

Note: Adjustments may need to be made to the ventilator when BiWaze Clear is connected in-line to accommodate the additional volume and flow added to the ventilator circuit. If adjustments are made, note the original settings so you can restore the original settings after BiWaze Clear therapy is complete.

6. The patient should be monitored throughout therapy and mucus from upper airways should be suctioned as necessary. If suctioning is required:
 - Remove the BiWaze Clear handset from the spring-valved tee.
 - Cap the spring-valved tee adapter.
 - Pause therapy on BiWaze Clear.
 - Suction the patient as necessary.
 - Resume the therapy on BiWaze Clear.
 - Remove the spring-valved tee adapter cap.
 - Insert the Dual Lumen Breathing Circuit's handset into the spring-valved tee as described in step 5.
7. When the BiWaze Clear therapy is complete, immediately:
 - Remove the Dual Lumen Breathing Circuit's handset from the spring-valved tee.
 - Cap the spring-valved tee adapter.
 - Stop the BiWaze Clear therapy.
 - Restore the ventilator parameters to their original settings if changes were made during the BiWaze Clear therapy.
 - Restore filters (if removed)

Cleaning and Maintenance



WARNING - Remove the power cord from the control unit and wall outlet before cleaning.

Unplug the control unit and clean the front panel and exterior of the enclosure (excluding the Dual Lumen Breathing Circuit) as needed. You can also clean the Aerogen power cable and BiWaze power cord when not plugged in. Use one of the following cleaning agents:

- A clean cloth dampened with water and a mild detergent.
- 70% Isopropyl alcohol or similar alcohol based towelettes used for medical devices with less than 70% Isopropyl alcohol.
- 10% Chlorine bleach solution

Inspect the control unit and power cables for damage after cleaning. Replace any damaged parts. Allow the device to dry completely before plugging in the power cord.

The disposable Dual Lumen Breathing Circuit is for single patient use only. The coaxial tube, handset and patient interface should be washed thoroughly with mild dishwashing detergent and warm clean water or per facility protocol. Place these parts on a lint free towelette to air dry completely before reuse.

Note: After each therapy session, gently shake the standard filter trap to remove any built-up nebulizer fluid.

Note: Do not clean or sterilize the Aerogen® Solo nebulizer cup.

Note: The disposable Dual Lumen Breathing Circuit is for a single patient use only and intended for 30 days of treatment or a maximum of 90 treatment sessions.

Under normal usage, you should clean the inlet air filter at least once every 1 month and replace it with a new one every six months.

For detailed Warning and Caution statements, cleaning, and operating instructions refer to the BiWaze® Clear System User Manual (BK381).



Training



Website

BiWaze® and ABM Respiratory Care® are trademarks of ABMRC, LLC.
©2025 ABMRC, LLC. ALL RIGHTS RESERVED. BK388 Rev 4.0 MAR-2025 ENG

Rx Only

For further information about this product or a service, visit our webpage:
www.abmrc.com or call customer support: 1-877-ABMRC01 (877-226-7201)

BiWaze® Clear System – Quick Reference Guide

abm.
RESPIRATORY CARE